

6-FM-150

FM Series
For General Use

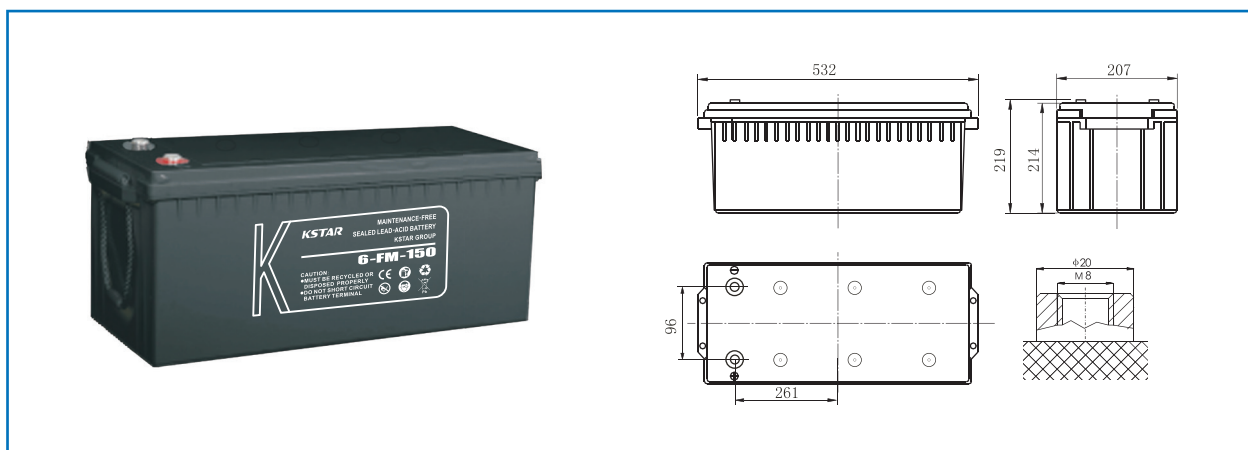

Specifications

Nominal Voltage	12V	
Rated Capacity (20 hour rate)	150Ah	
Dimensions	Total Height (with terminals)	8.62 inches(219mm)
	Height	8.43 inches(214mm)
	length	20.94 inches(532mm)
	width	8.15 inches(207mm)
Weight	Approx.104.5 Pound(47.5kg)	

Characteristics

Capacity 77°F(25°C)	20 hour rate (7.5A)	150 Ah
	10 hour rate (13.8A)	138 Ah
	5 hour rate (24.0A)	120 Ah
	1 hour rate (90.0A)	90 Ah
	15Minute Rate (246A)	61.5 Ah
Internal Resistance	Full charged Battery 77°F(25°C)	3.5 mΩ
	104°F(40°C)	102%
Capacity affected by Temperature (20hour rate)	77°F(25°C)	100%
	32°F(0°C)	85%
	5°F(-15°C)	65%
	Capacity after 3 month storage	91%
Self-Discharge 77°F(25°C)	Capacity after 6 month storage	81%
	Capacity after 12 month storage	60%
	Max. Discharge Current 77°F(25°C)	1000A(5S)
Terminal	M3	
Charge (Constant Voltage)	Cycle	Initial Charging Current less than 45A
		Voltage 14.4~14.7 V / 77°F(25°C)
	Float	Voltage 13.5~13.8V / 77°F(25°C)

Discharge Curves 77 °F (25°C)

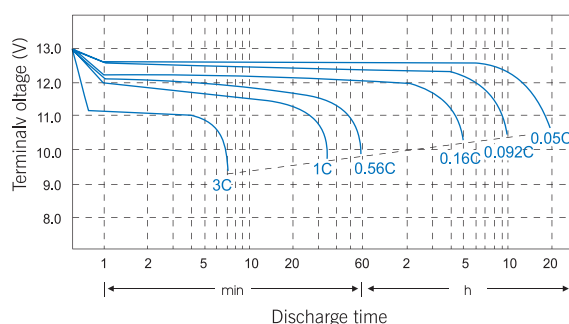

Relationship between charge voltage and temperature

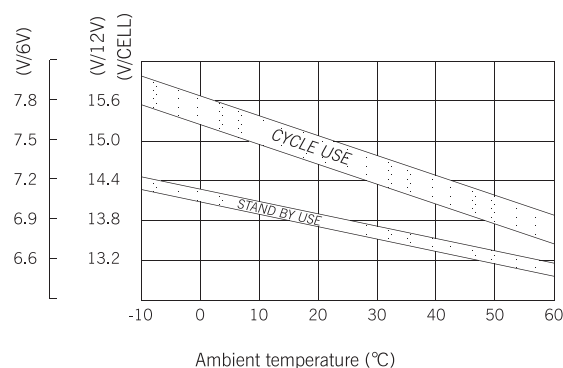

Constant Current Discharge (AMPERES @25°C)

F.V/Time	10Min	15Min	30Min	60Min	2H	3H	4H	5H	8H	10H	20H
1.60	339	246	159	94.2	55.6	39.5	31.0	26.5	18.0	14.8	7.70
1.65	326	237	153	90.6	53.5	39.2	30.7	26.3	17.8	14.7	7.62
1.70	308	236	130	90.2	53.2	37.5	29.5	25.4	17.6	14.4	7.58
1.75	270	214	122	90.0	53.0	36.8	28.6	24.0	17.5	13.8	7.50
1.80	260	206	118	86.5	51.0	35.4	27.5	23.1	16.8	13.3	7.21
1.85	213	179	108	79.6	49.0	33.6	26.1	21.9	16.0	12.6	6.85

Constant Power Discharge (WATTS PER CELL@25°C)

F.V/Time	10Min	15Min	30Min	60Min	2H	3H	4H	5H	8H	10H	20H
1.60	583	454	286	178	106	73.7	58.1	48.6	33.5	27.8	14.6
1.65	576	451	282	175	104	72.0	57.0	48.1	33.4	27.6	14.5
1.70	560	441	247	168	102	70.4	55.8	47.1	33.1	27.2	14.3
1.75	519	411	234	162	101	69.6	55.1	46.5	32.5	27.0	14.2
1.80	487	391	214	159	100	68.7	54.1	45.2	32.1	26.5	13.9
1.85	404	342	208	148	95.5	67.8	53.1	44.0	29.9	25.2	13.7

The operating environment temperature above 40°C should be avoided ,After long term storage, The battery actual capacity would be less than the rated capacity. Full capacity will be obtained through several charge/discharge cycles.
To get the longest life, KSTAR battery should be fully charged before storage.

Cycle service life in relation to depth of discharge

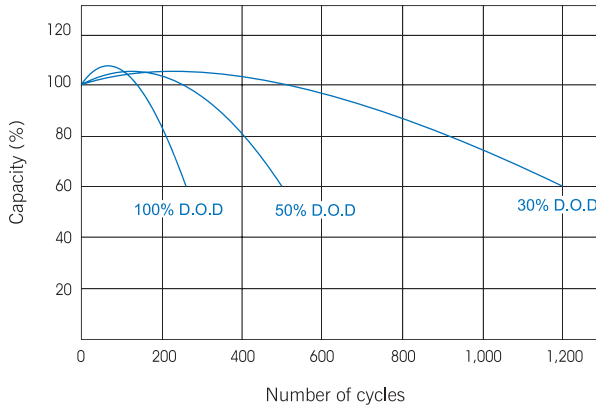

Constant voltage charge characteristic

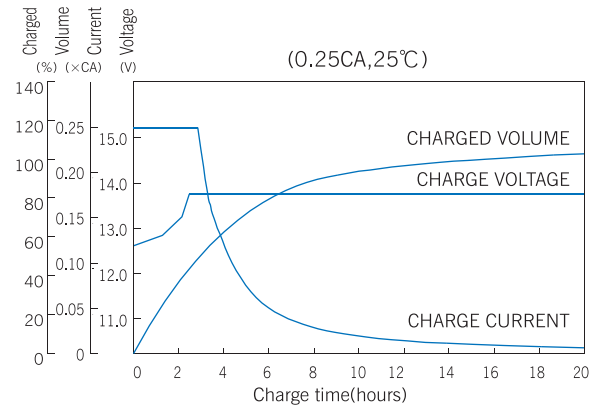

Self-Discharge Characteristics

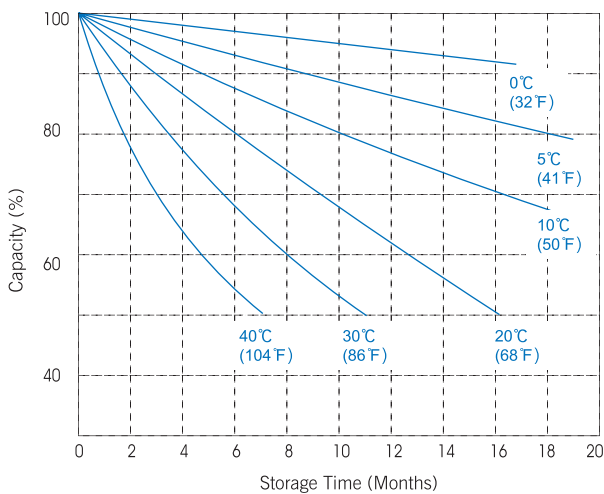

Relationship of OCV and Residual Capacity % (25°C)

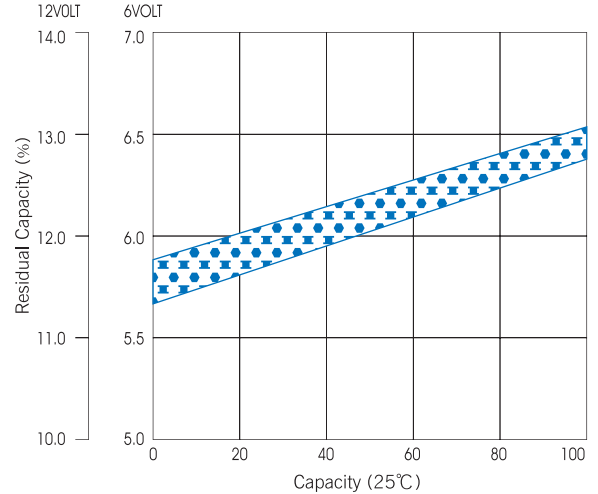

Temperature effects on capacity

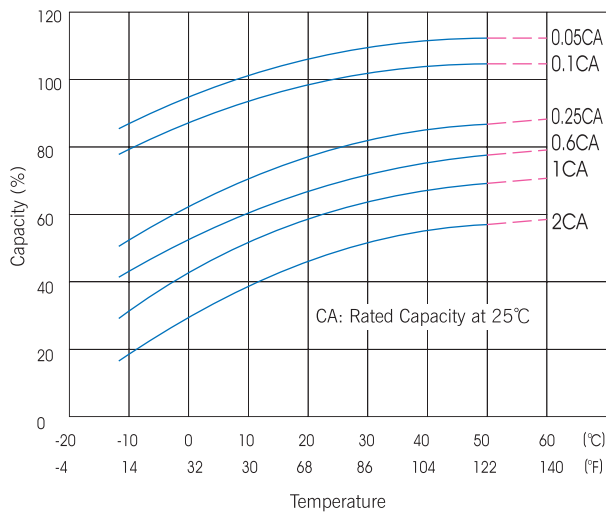

Temperature effects float life

