

6-FM-65A

FM Series
For General Use

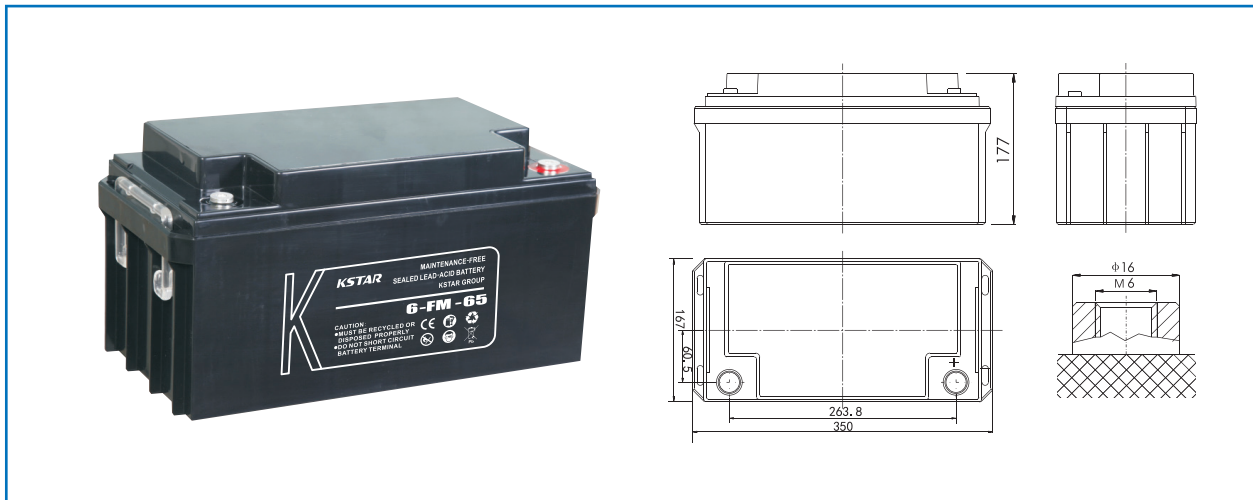

Specifications

Nominal Voltage	12V	
Rated Capacity (20 hour rate)	65Ah	
Dimensions	Total Height (with terminals)	6.97 inches(177mm)
	Height	6.97 inches(177mm)
	length	13.8 inches(350mm)
	width	6.57 inches(167mm)
Weight	Approx.43.34 Pound(19.7kg)	

Characteristics

Capacity 77°F(25°C)	20 hour rate (3.25A)	65 Ah
	10 hour rate (6.10A)	59.8 Ah
	5 hour rate (10.4A)	52 Ah
	1hour rate (39.0A)	39 Ah
	15Minute Rate (107A)	26.8 Ah
Internal Resistance	Full charged Battery 77°F(25°C)	7.0 mΩ
	104°F(40°C)	102%
Capacity affected by Temperature (20hour rate)	77°F(25°C)	100%
	32°F(0°C)	85%
	5°F(-15°C)	65%
	Capacity after 3 month storage	91%
Self-Discharge 77°F(25°C)	Capacity after 6 month storage	81%
	Capacity after 12 month storage	60%
	Max. Discharge Current 77°F(25°C)	650A(5S)
Terminal	M2 / B5 / B11	
Charge (Constant Voltage)	Cycle	Initial Charging Current less than 19.5A
		Voltage 14.4~14.7 V / 77°F(25°C)
	Float	Voltage 13.5~13.8V / 77°F(25°C)

Constant Current Discharge (AMPERES @25°C)

F.V/Time	10Min	15Min	30Min	60Min	2H	3H	4H	5H	8H	10H	20H
1.60	146	107	70.9	41.6	24.5	16.8	13.2	11.4	7.73	6.48	3.39
1.65	140	103	68.2	40.0	23.6	16.6	13.1	11.3	7.65	6.42	3.36
1.70	133	101	64.8	39.2	23.2	16.3	12.8	10.9	7.43	6.26	3.34
1.75	116	91.9	56.2	39.0	22.5	15.9	12.4	10.4	7.34	5.98	3.25
1.80	112	88.4	54.0	37.5	21.6	15.3	11.9	10.0	7.06	5.75	3.13
1.85	91.8	76.9	49.7	34.5	20.7	14.5	11.3	9.50	6.71	5.46	2.97

Constant Power Discharge (WATTS PER CELL@25°C)

Cut off voltage V/cell	10Min	15Min	30Min	60Min	2H	3H	4H	5H	8H	10H	20H
1.60	254	194	127	77.2	45.3	31.8	25.0	20.9	14.2	11.8	6.42
1.65	251	192	124	76.4	44.7	31.5	24.8	20.7	14.1	11.6	6.40
1.70	246	187	121	75.0	43.6	31.2	24.5	20.3	13.9	11.3	6.35
1.75	230	182	111	74.8	43.1	30.8	24.2	20.1	13.8	11.2	6.32
1.80	214	170	104	74.4	42.4	30.1	23.8	20.0	13.5	11.0	6.30
1.85	177	149	96.0	69.2	41.4	29.7	23.2	19.1	13.0	10.9	5.94

Discharge Curves 77°F (25°C)

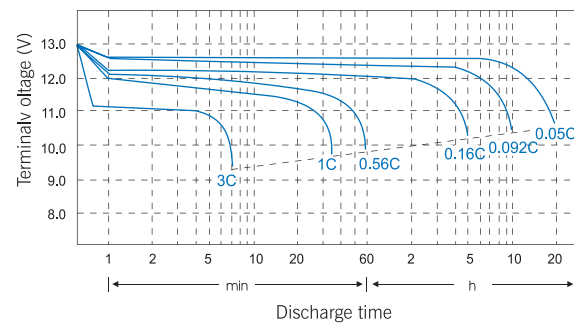

Relationship between charge voltage and temperature

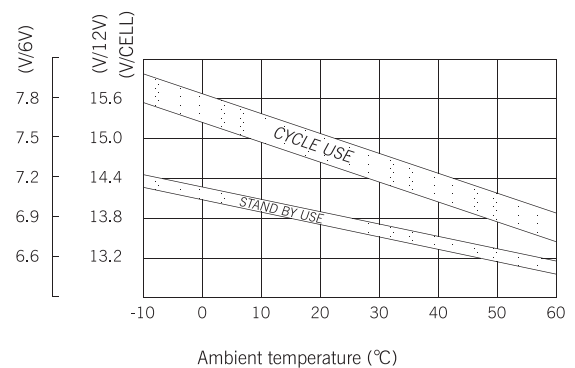

The operating environment temperature above 40°C should be avoided. After long term storage, The battery actual capacity would be less than the rated capacity. Full capacity will be obtained through several charge/discharge cycles. To get the longest life, KSTAR battery should be fully charged before storage.

■ Cycle service life in relation to depth of discharge

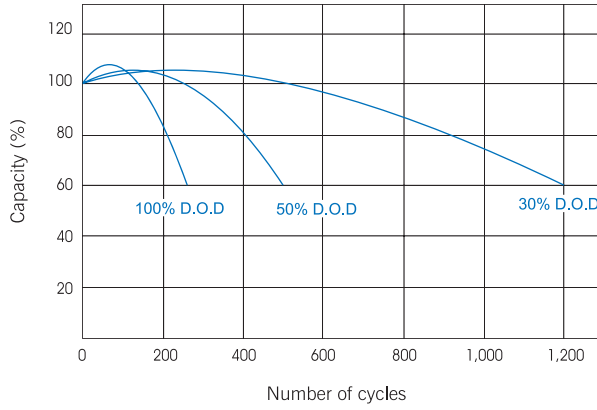

■ Constant voltage charge characteristic

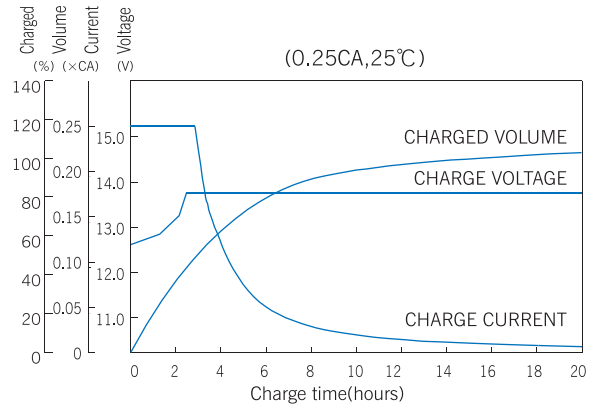

■ Self-Discharge Characteristics

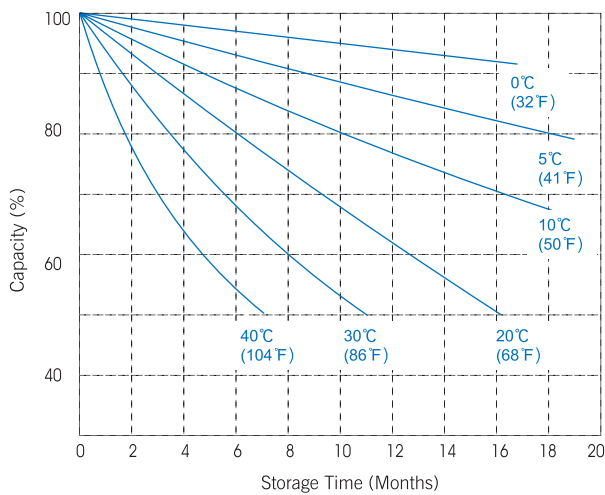

■ Relationship of OCV and Residual Capacity % (25°C)

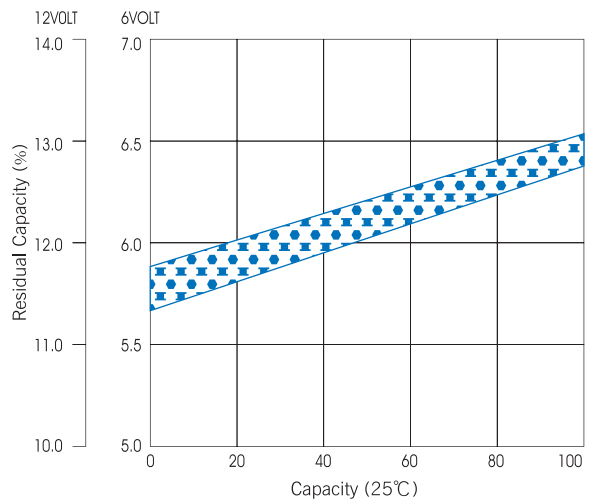

■ Temperature effects on capacity

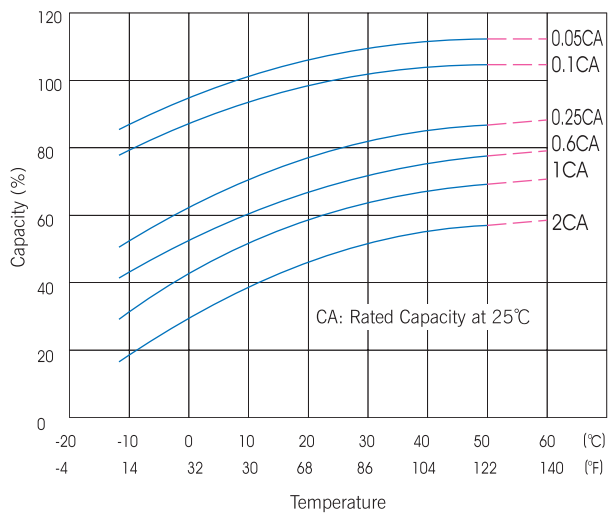

■ Temperature effects float life

