

# 6-FM-38A

FM Series  
For General Use

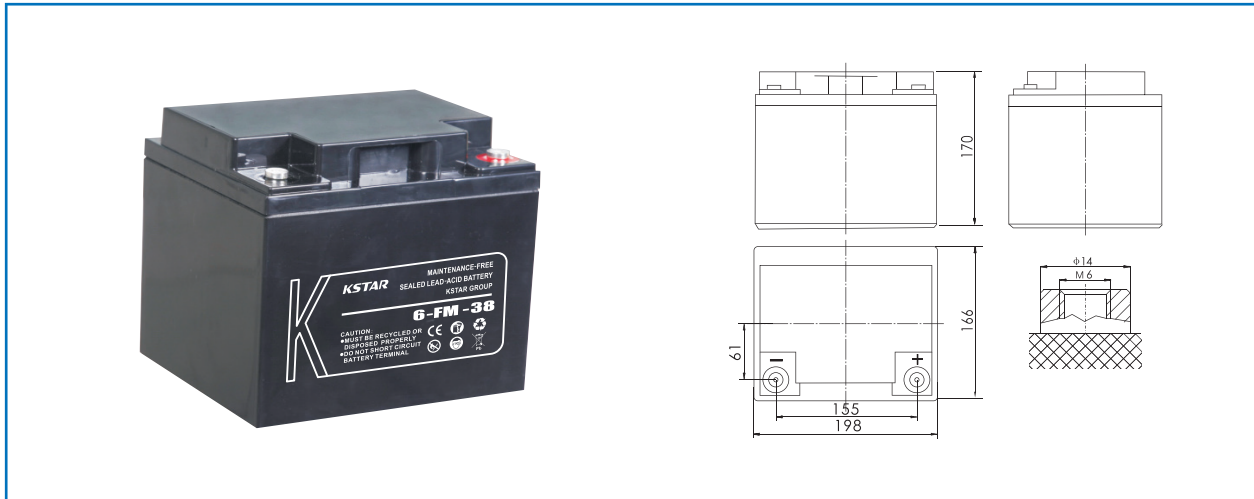

## Specifications

Nominal Voltage	12V	
Rated Capacity (20 hour rate)	38Ah	
Dimensions	Total Height (with terminals)	6.70 inches(170mm)
	Height	6.70 inches(170mm)
	length	7.80 inches(198mm)
	width	6.54 inches(166mm)
Weight	Approx.24.86 Pound(12.0kg)	

## Characteristics

Capacity 77°F(25°C)	20 hour rate (1.90A)	38.0 Ah
	10 hour rate ( 3.50A)	35.0 Ah
	5 hour rate (6.08A)	30.4 Ah
	1 hour rate (22.8A)	22.8 Ah
	15Minute Rate (62.8A)	15.7 Ah
Internal Resistance	Full charged Battery 77°F(25°C)	12 mΩ
	104°F(40°C)	102%
Capacity affected by Temperature (20hour rate)	77°F(25°C)	100%
	32°F(0°C)	85%
	5°F(-15°C)	65%
Self-Discharge 77°F(25°C)	Capacity after 3 month storage	91%
	Capacity after 6 month storage	81%
	Capacity after 12 month storage	60%
Max. Discharge Current 77°F(25°C)	380A(5S)	
Terminal	M1	
Charge (Constant Voltage)	Cycle	Initial Charging Current less than 11.4A
		Voltage 14.4~14.7 V / 77°F(25°C)
	Float	Voltage 13.5~13.8V / 77°F(25°C)

## Discharge Curves 77°F (25°C)

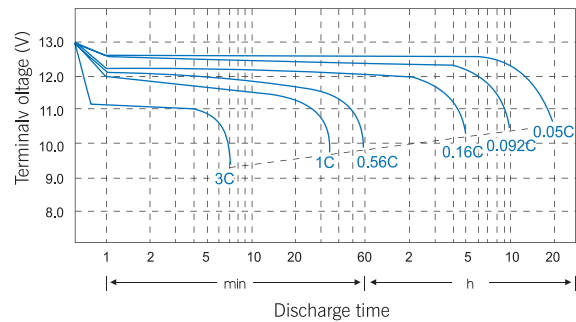

## Relationship between charge voltage and temperature

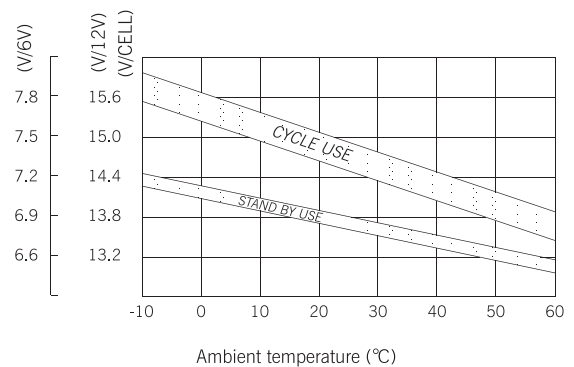

## Constant Current Discharge (AMPERES @25°C)

F.V/Time	10Min	15Min	30Min	60Min	2H	3H	4H	5H	8H	10H	20H
1.60	80.7	62.8	39.8	24.5	13.9	9.89	7.72	6.53	4.61	3.77	1.98
1.65	77.6	60.4	38.3	23.6	13.4	9.79	7.64	6.47	4.56	3.73	1.96
1.70	73.1	57.3	36.2	23.3	13.0	9.50	7.38	6.21	4.48	3.66	1.95
1.75	63.6	50.9	34.6	22.8	13.0	9.39	7.27	6.08	4.37	3.50	1.90
1.80	61.2	48.9	33.3	21.9	12.5	9.03	6.99	5.85	4.20	3.37	1.83
1.85	50.2	42.5	30.6	20.1	12.0	8.58	6.64	5.56	3.99	3.20	1.74

## Constant Power Discharge (WATTS PER CELL@25°C)

F.V/Time	10Min	15Min	30Min	60Min	2H	3H	4H	5H	8H	10H	20H
1.60	143	113	70.2	44.6	25.3	18.0	14.3	12.1	8.00	6.76	3.50
1.65	139	110	69.7	43.2	24.5	17.8	14.1	11.9	7.94	6.70	3.48
1.70	135	106	67.6	41.9	24.2	17.5	13.8	11.6	7.75	6.56	3.37
1.75	127	102	67.4	41.6	24.0	17.4	13.7	11.5	7.68	6.50	3.31
1.80	117	94.1	64.1	40.9	23.6	17.0	13.4	11.3	7.42	6.28	3.22
1.85	96.9	82.7	58.3	38.0	22.7	16.5	12.9	10.7	7.21	6.00	3.12

The operating environment temperature above 40°C should be avoided ,After long term storage, The battery actual capacity would be less than the rated capacity. Full capacity will be obtained through several charge/discharge cycles.  
To get the longest life, KSTAR battery should be fully charged before storage.

### Cycle service life in relation to depth of discharge

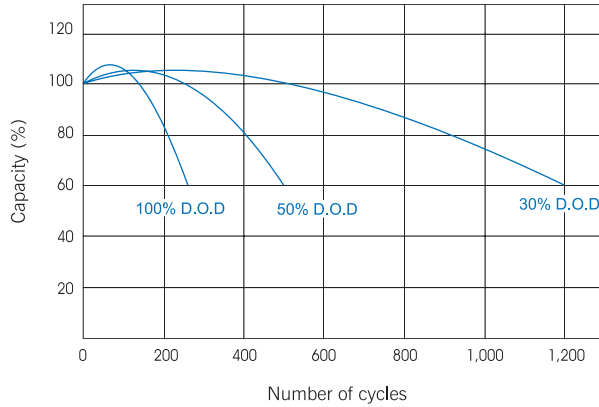

### Constant voltage charge characteristic

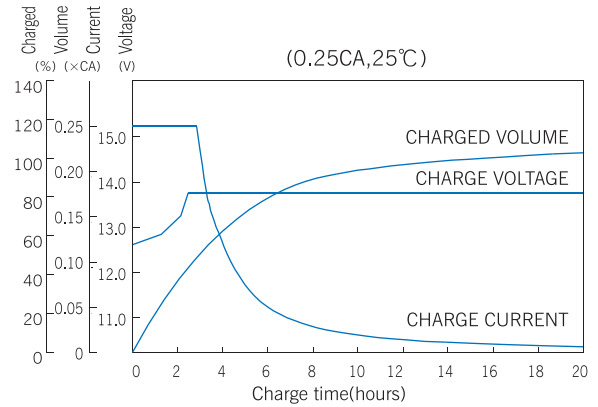

### Self-Discharge Characteristics

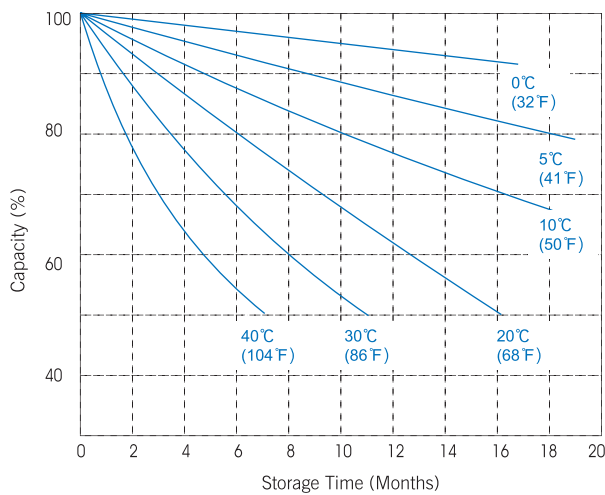

### Relationship of OCV and Residual Capacity % (25°C)

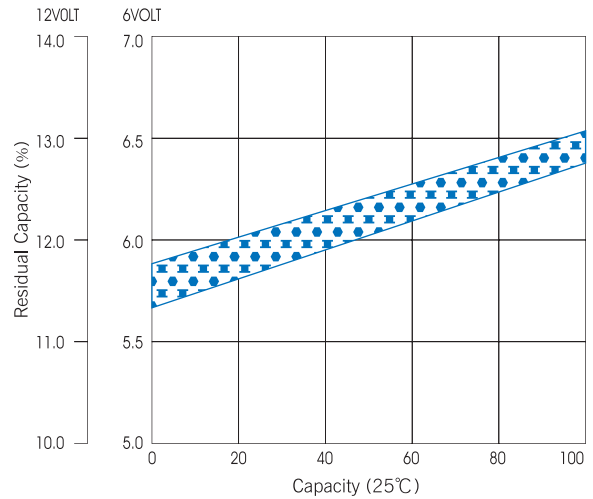

### Temperature effects on capacity

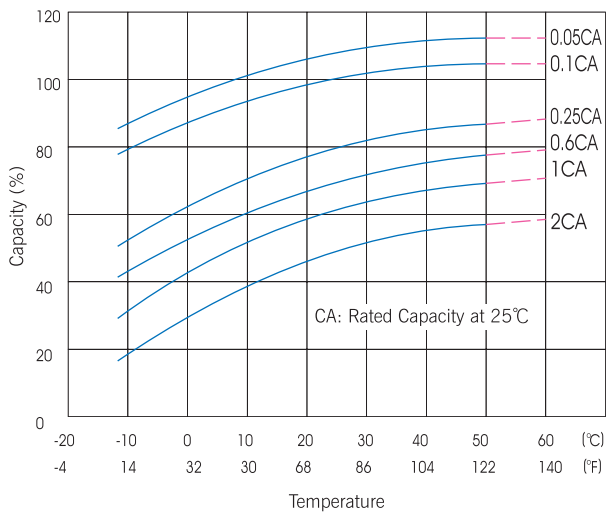

### Temperature effects float life

