

6-FM-7

FM Series
Battery For General Use

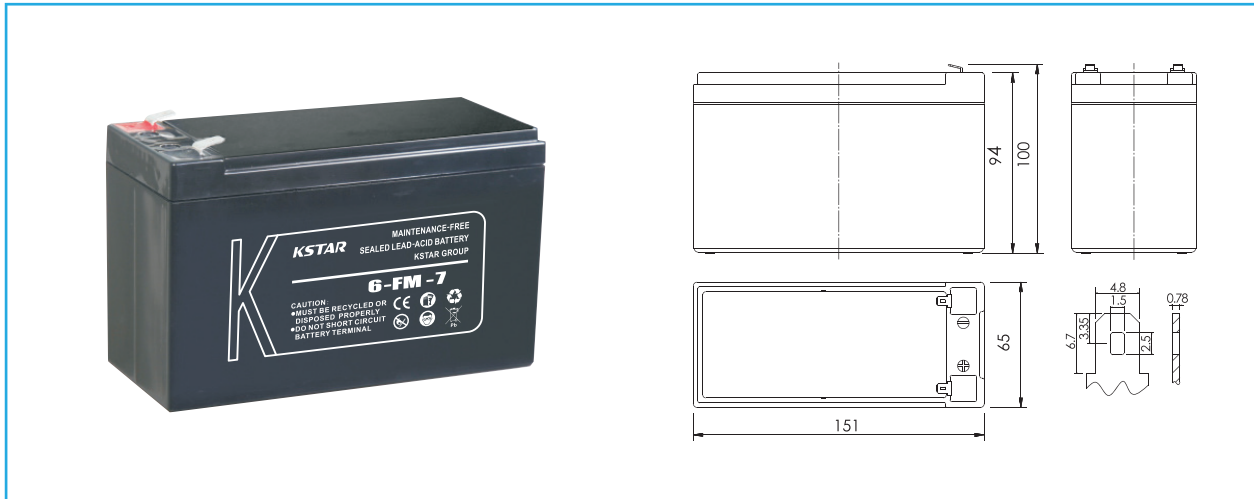

Specifications

Nominal Voltage		12V
Rated Capacity (20 hour rate)		7.0Ah
Dimensions	Total Height (with terminals)	3.94 inches(100mm)
	Height	3.70 inches(94mm)
	length	5.94 inches(151mm)
	width	2.56 inches(65mm)
Weight		Approx.4.84 Pound(2.20kg)

Characteristics

Capacity 77°F(25°C)	20 hour rate (0.35A)	7.0 Ah
	10 hour rate (0.65A)	6.5 Ah
	5 hour rate (1.12A)	5.6 Ah
	1hour rate (4.20 A)	4.2 Ah
	15Minute Rate (12.3 A)	3.1 Ah
Internal Resistance	Full charged Battery 77°F(25°C)	22mΩ
	104°F(40°C)	102%
Capacity affected by Temperature (20hour rate)	77°F(25°C)	100%
	32°F(0°C)	85%
	5°F(-15°C)	65%
	Capacity after 3 month storage	91%
Self-Discharge 77°F(25°C)	Capacity after 6 month storage	81%
	Capacity after 12 month storage	60%
	Max. Discharge Current 77°F(25°C)	105A(5S)
Terminal		F1 \ F2
Charge (Constant Voltage)	Cycle	Initial Charging Current less than 2.1A
		Voltage 14.4~14.7 V / 77°F(25°C)
	Float	Voltage 13.5~13.8V / 77°F(25°C)

Discharge Curves 77°F (25°C)

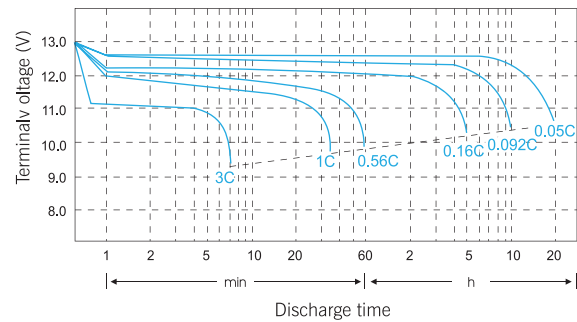

Relationship between charge voltage and temperature

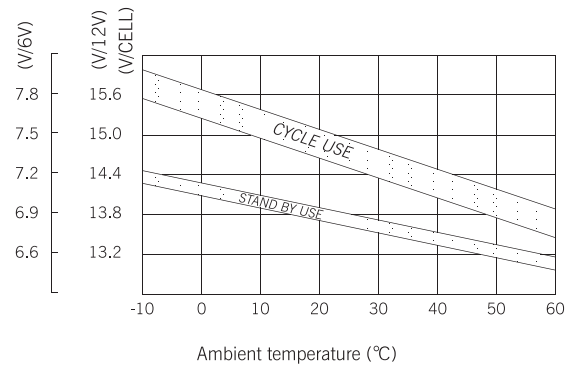

Constant Current Discharge (AMPERES @25°C)

F.V/Time	5Min	10Min	15Min	30Min	60Min	2H	3H	4H	5H	10H	20H
1.60	26.7	16.9	12.3	7.56	4.45	2.61	1.80	1.40	1.15	0.669	0.359
1.65	26.0	16.5	11.9	7.36	4.37	2.52	1.77	1.37	1.14	0.653	0.356
1.70	24.9	15.8	11.4	7.22	4.29	2.49	1.76	1.36	1.14	0.653	0.353
1.75	23.8	15.1	11.2	7.14	4.20	2.46	1.76	1.34	1.12	0.650	0.350
1.80	22.4	15.0	10.9	6.94	4.12	2.38	1.73	1.33	1.10	0.638	0.342

Constant Power Discharge (WATTS PER CELL@25°C)

F.V/Time	5Min	10Min	15Min	30Min	60Min	2H	3H	4H	5H	10H	20H
1.60	49.5	31.6	23.4	14.4	8.06	5.08	3.58	2.79	2.29	1.32	0.710
1.65	48.5	30.9	22.6	14.0	7.96	4.93	3.53	2.73	2.26	1.31	0.708
1.70	46.1	29.6	21.7	13.8	7.81	4.85	3.50	2.72	2.27	1.31	0.705
1.75	44.3	28.5	21.3	13.7	7.63	4.80	3.50	2.69	2.24	1.31	0.703
1.80	41.7	28.3	20.8	13.2	7.51	4.67	3.45	2.66	2.21	1.28	0.690

The operating environment temperature above 40°C should be avoided. After long term storage, The battery actual capacity would be less than the rated capacity. Full capacity will be obtained through several charge/discharge cycles. To get the longest life, KSTAR battery should be fully charged before storage.

■ Cycle service life in relation to depth of discharge

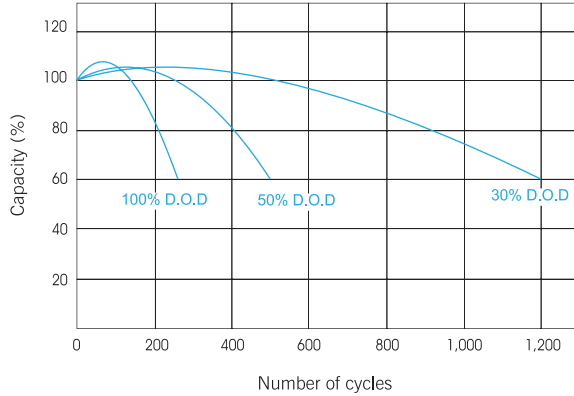

■ Constant voltage charge characteristic

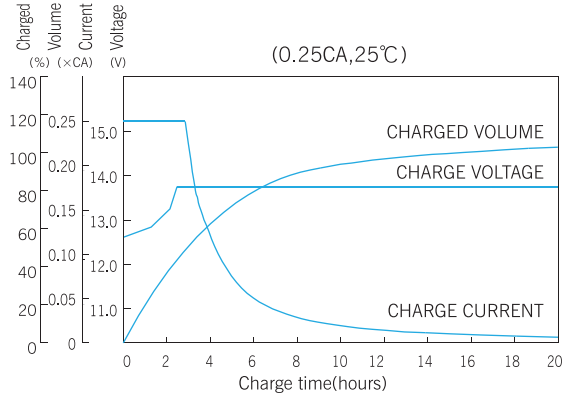

■ Self-Discharge Characteristics

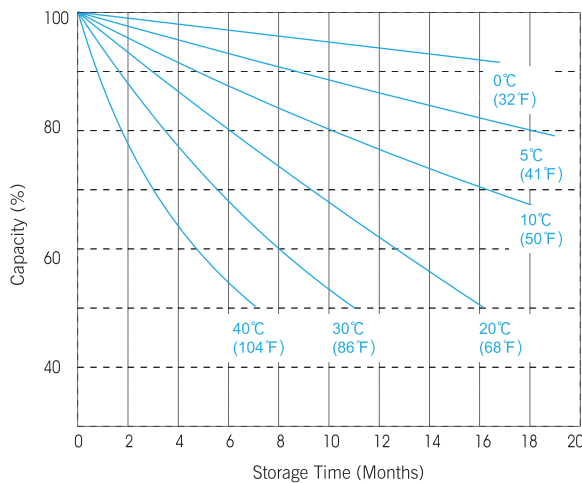

■ Relationship of OCV and Residual Capacity % (25°C)

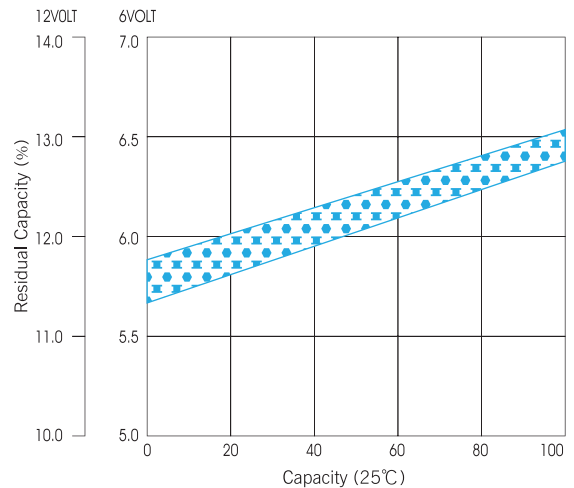

■ Temperature effects on capacity

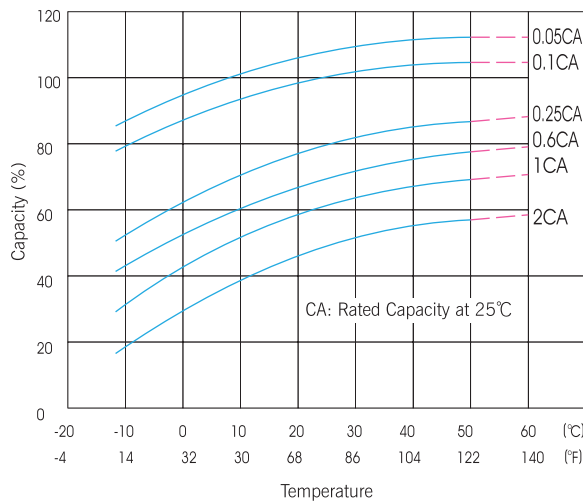

■ Temperature effects float life

